

Battery Operated Single Roller Shade

Scale: NTS

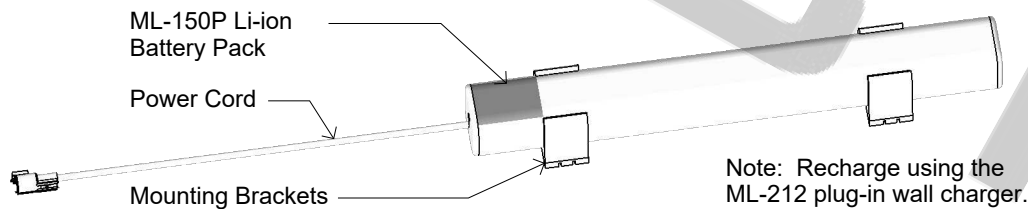

Li-ion Rechargeable Battery Pack

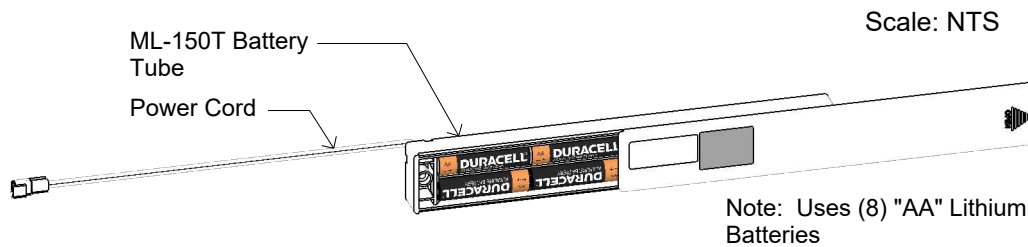

"AA" Battery Tube

Scale: NTS

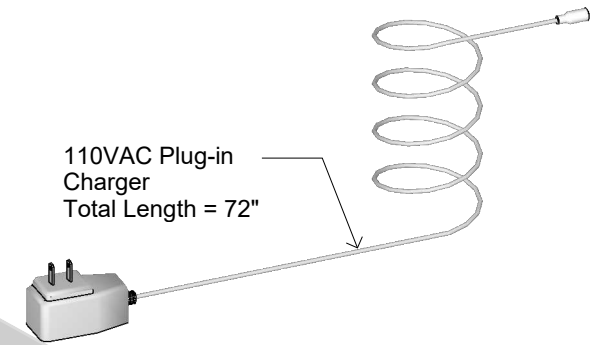

Plug-In Wall Charger (ML-212)

Scale: NTS

ML-280SC Motor
12VDC
1.5 Nm Torque
28 RPM
1.2A
14.4 Watts
Charge Time: 6 Hrs
Cycles/Charge: 600

General Installation Notes:

- 1) The ML-280SC motor is the smallest battery motor with a whopping 1.5Nm strength. Designed with an external battery source (Li-ion battery or AA), this motor is easily maintained by a low current trickle charge which is to be provided by a small plug-in charger.
- 2) The plug-in charger can be set up to permanently charge the battery, or only be plugged in for a few hours every 6-12 months, or as motor use levels require.
- 3) The ML-280SC is set up for wireless wall mounted and hand-held remote options but also has wired Dry Contact capabilities allowing for a 3rd party system integration. Weighing in at only 1.0 KG, the ML-280SC produces less than 40bDA, powers shades on 1.5" tubes, and can accommodate a minimum shade width of 21" and a maximum drop of 96".

ROLLER SHADE OPERATION

See Attached Roller Shade Switch / Remote Option Sheet for Control Availability

ML-280SC Battery Operated Motor w/ RF Control Inside Mounted Single Roller Shade Wiring Diagram

Scale: NTS

By: MJW

Date:

10/15/19

Rev: 01/01/22

CONFIDENTIAL -
All materials disclosed in this document are proprietary to Fabtex, Inc. The holder agrees to maintain it in confidence and must not replicate or reveal this information in any manner.

PRODUCT DISCLAIMER - Fabtex is a manufacturer of commercial products that require installation by a licensed contractor. All information shown is for schematic purposes and to aid coordination amongst trades. All wiring, connections, means and methods is to be performed by others in strict adherence with all federal, state, and local building codes.



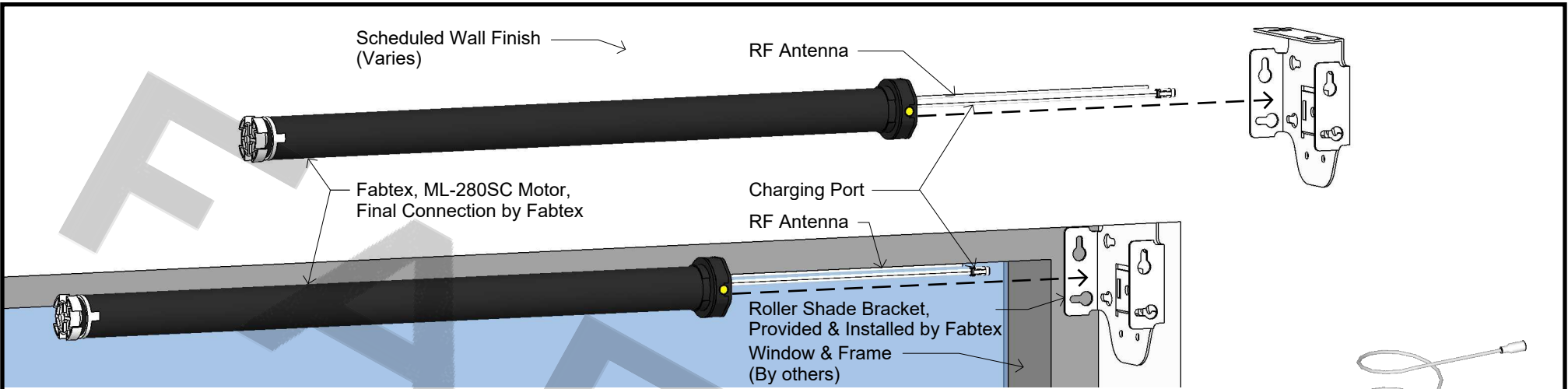

Battery Operated Split Roller Shades

Scale: NTS

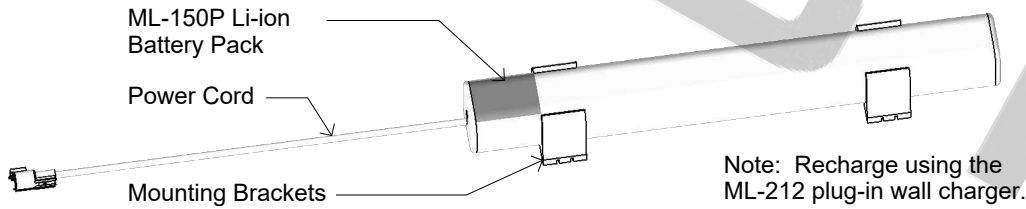

Note: Recharge using the ML-212 plug-in wall charger.

Li-ion Rechargeable Battery Pack

Scale: NTS

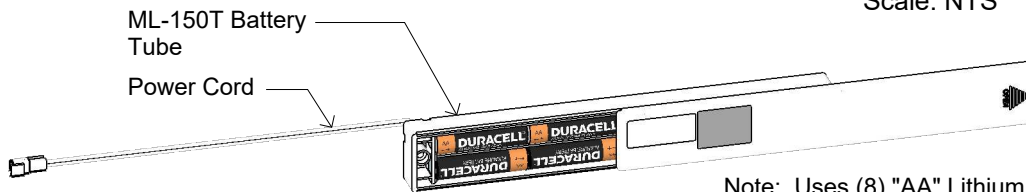

"AA" Battery Tube

Scale: NTS

Plug-In Wall Charger (ML-212)

Scale: NTS

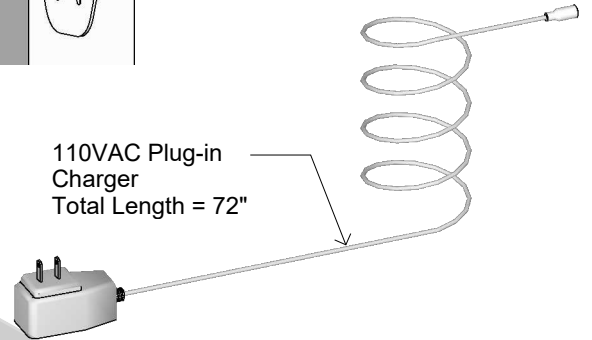

ML-280SC Motor
12VDC
1.5 Nm Torque
28 RPM
1.2A
14.4 Watts
Charge Time: 6 Hrs
Cycles/Charge: 600

General Installation Notes:

- 1) The ML-280SC motor is the smallest battery motor with a whopping 1.5Nm strength. Designed with an external battery source (Li-ion battery or AA), this motor is easily maintained by a low current trickle charge which is to be provided by a small plug-in charger.
- 2) The plug-in charger can be set up to permanently charge the battery, or only be plugged in for a few hours every 6-12 months, or as motor use levels require.
- 3) The ML-280SC is set up for wireless wall mounted and hand-held remote options but also has wired Dry Contact capabilities allowing for a 3rd party system integration. Weighing in at only 1.0 KG, the ML-280SC produces less than 40bDA, powers shades on 1.5" tubes, and can accommodate a minimum shade width of 21" and a maximum drop of 96".

ROLLER SHADE OPERATION
See Attached Roller Shade Switch / Remote Option Sheet for Control Availability

ML-280SC Battery Operated Motor w/ RF Control Split Mount (ISM & OSM) Roller Shade Wiring Diagram

Scale: NTS

By: MJW

Date:

10/15/19
Rev: 01/01/22

CONFIDENTIAL -
All materials disclosed in this document are proprietary to Fabtex, Inc. The holder agrees to maintain it in confidence and must not replicate or reveal this information in any manner.



PRODUCT DISCLAIMER - Fabtex is a manufacturer of commercial products that require installation by a licensed contractor. All information shown is for schematic purposes and to aid coordination amongst trades. All wiring, connections, means and methods is to be performed by others in strict adherence with all federal, state, and local building codes.

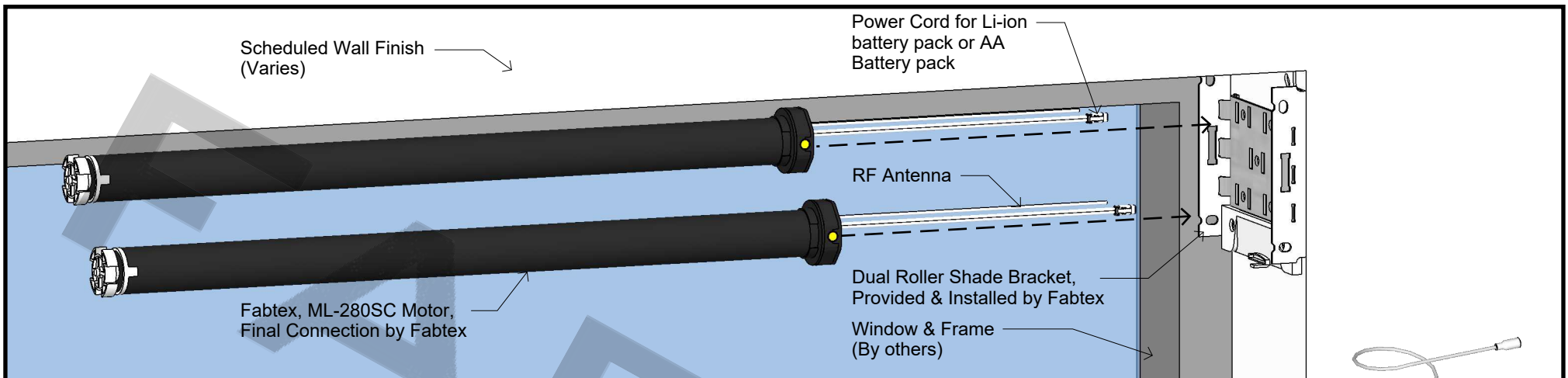

Battery Operated Dual Roller Shade

Scale: NTS

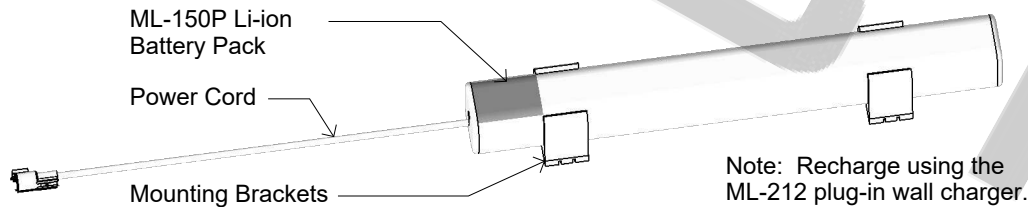

Li-ion Rechargeable Battery Pack

Scale: NTS

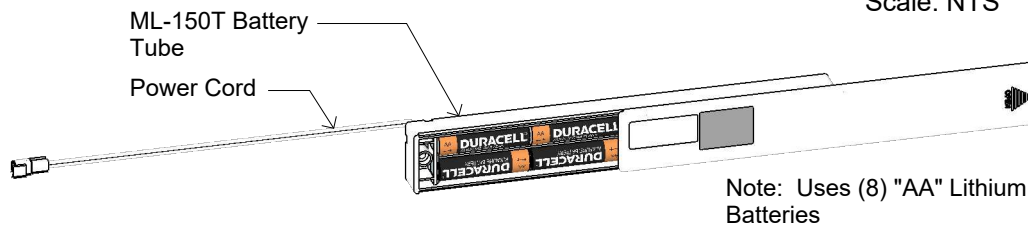

"AA" Battery Tube

Scale: NTS

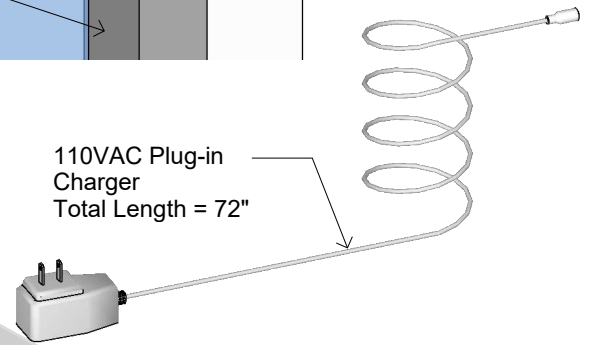

Plug-In Wall Charger (ML-212)

Scale: NTS

ML-280SC Motor
12VDC
1.5 Nm Torque
28 RPM
1.2A
14.4 Watts
Charge Time: 6 Hrs
Cycles/Charge: 600

General Installation Notes:

- 1) The ML-280SC motor is the smallest battery motor with a whopping 1.5Nm strength. Designed with an external battery source (Li-ion battery or AA), this motor is easily maintained by a low current trickle charge which is to be provided by a small plug-in charger.
- 2) The plug-in charger can be set up to permanently charge the battery, or only be plugged in for a few hours every 6-12 months, or as motor use levels require.
- 3) The ML-280SC is set up for wireless wall mounted and hand-held remote options but also has wired Dry Contact capabilities allowing for a 3rd party system integration. Weighing in at only 1.0 KG, the ML-280SC produces less than 40bDA, powers shades on 1.5" tubes, and can accommodate a minimum shade width of 21" and a maximum drop of 96".

ROLLER SHADE OPERATION
See Attached Roller Shade Switch / Remote Option Sheet for Control Availability

ML-280SC Battery Operated Motor w/ RF Control Inside Mounted Dual Roller Shade Wiring Diagram

Scale: NTS

By: MJW

Date:

10/15/19
Rev: 01/01/22

CONFIDENTIAL -
All materials disclosed in this document are proprietary to Fabtex, Inc. The holder agrees to maintain it in confidence and must not replicate or reveal this information in any manner.



PRODUCT DISCLAIMER - Fabtex is a manufacturer of commercial products that require installation by a licensed contractor. All information shown is for schematic purposes and to aid coordination amongst trades. All wiring, connections, means and methods is to be performed by others in strict adherence with all federal, state, and local building codes.

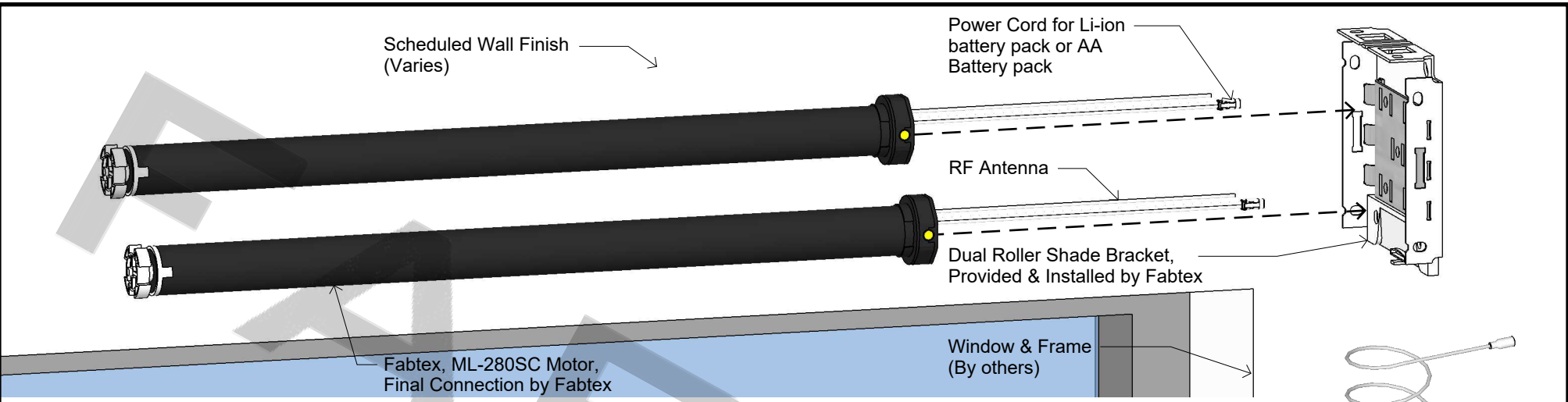

Battery Operated Dual Roller Shade

Scale: NTS

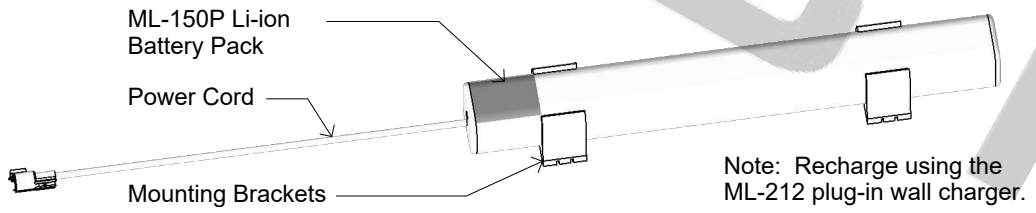

Note: Recharge using the ML-212 plug-in wall charger.

Li-ion Rechargeable Battery Pack

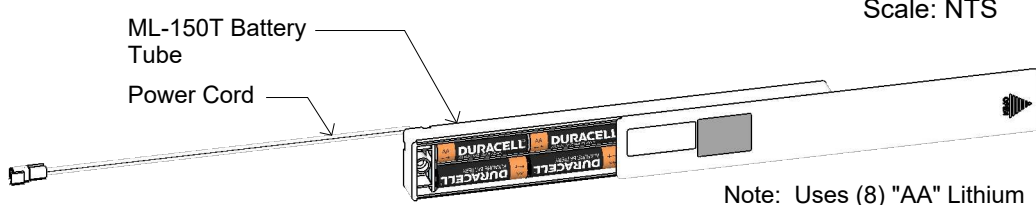

Note: Uses (8) "AA" Lithium Batteries

"AA" Battery Tube

Scale: NTS

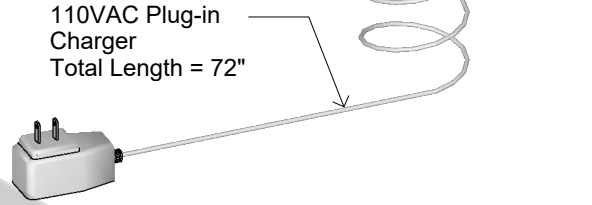

Plug-In Wall Charger (ML-212)

Scale: NTS

ML-280SC Motor
12VDC
1.5 Nm Torque
28 RPM
1.2A
14.4 Watts
Charge Time: 6 Hrs
Cycles/Charge: 600

General Installation Notes:

- 1) The ML-280SC motor is the smallest battery motor with a whopping 1.5Nm strength. Designed with an external battery source (Li-ion battery or AA), this motor is easily maintained by a low current trickle charge which is to be provided by a small plug-in charger.
- 2) The plug-in charger can be set up to permanently charge the battery, or only be plugged in for a few hours every 6-12 months, or as motor use levels require.
- 3) The ML-280SC is set up for wireless wall mounted and hand-held remote options but also has wired Dry Contact capabilities allowing for a 3rd party system integration. Weighing in at only 1.0 KG, the ML-280SC produces less than 40bDA, powers shades on 1.5" tubes, and can accommodate a minimum shade width of 21" and a maximum drop of 96".

ROLLER SHADE OPERATION
See Attached Roller Shade Switch / Remote Option Sheet for Control Availability

ML-280SC Battery Operated Motor w/ RF Control Outside Mounted Dual Roller Shade Wiring Diagram

Scale: NTS
By: MJW
Date: 10/15/19
Rev: 01/01/22

CONFIDENTIAL -
All materials disclosed in this document are proprietary to Fabtex, Inc. The holder agrees to maintain it in confidence and must not replicate or reveal this information in any manner.



PRODUCT DISCLAIMER - Fabtex is a manufacturer of commercial products that require installation by a licensed contractor. All information shown is for schematic purposes and to aid coordination amongst trades. All wiring, connections, means and methods is to be performed by others in strict adherence with all federal, state, and local building codes.

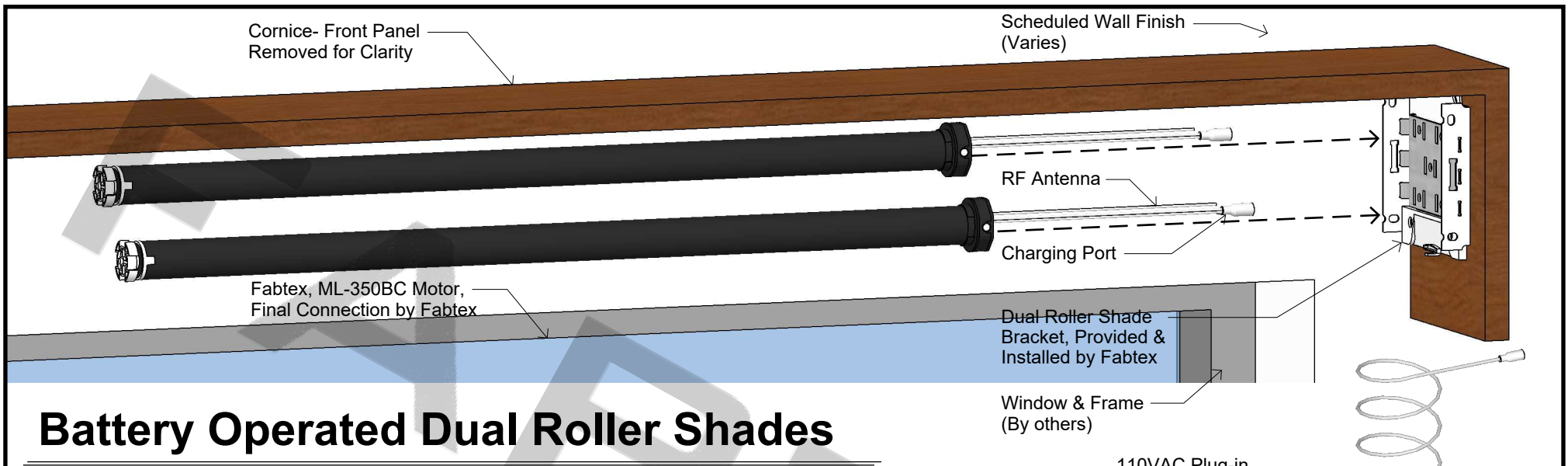

Battery Operated Dual Roller Shades

Scale: NTS

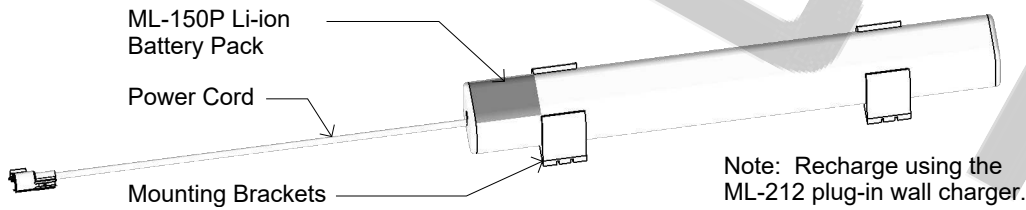

Note: Recharge using the ML-212 plug-in wall charger.

Li-ion Rechargeable Battery Pack

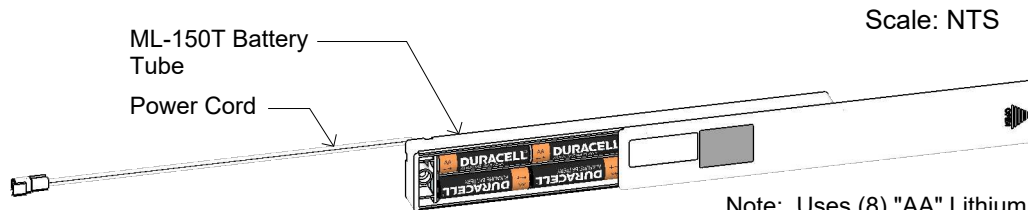

Note: Uses (8) "AA" Lithium Batteries

"AA" Battery Tube

Scale: NTS

Plug-In Wall Charger (ML-212)

Scale: NTS

ML-280SC Motor
12VDC
1.5 Nm Torque
28 RPM
1.2A
14.4 Watts
Charge Time: 6 Hrs
Cycles/Charge: 600

General Installation Notes:

- 1) The ML-280SC motor is the smallest battery motor with a whopping 1.5Nm strength. Designed with an external battery source (Li-ion battery or AA), this motor is easily maintained by a low current trickle charge which is to be provided by a small plug-in charger.
- 2) The plug-in charger can be set up to permanently charge the battery, or only be plugged in for a few hours every 6-12 months, or as motor use levels require.
- 3) The ML-280SC is set up for wireless wall mounted and hand-held remote options but also has wired Dry Contact capabilities allowing for a 3rd party system integration. Weighing in at only 1.0 KG, the ML-280SC produces less than 40bDA, powers shades on 1.5" tubes, and can accommodate a minimum shade width of 21" and a maximum drop of 96".

ROLLER SHADE OPERATION
See Attached Roller Shade Switch / Remote Option Sheet for Control Availability

ML-280SC Battery Operated Motor w/ RF Control Dual Roller Shade into Cornice Wiring Diagram

Scale: NTS

By: MJW

Date:

10/15/19
Rev: 01/01/22

CONFIDENTIAL -
All materials disclosed in this document are proprietary to Fabtex, Inc. The holder agrees to maintain it in confidence and must not replicate or reveal this information in any manner.



PRODUCT DISCLAIMER - Fabtex is a manufacturer of commercial products that require installation by a licensed contractor. All information shown is for schematic purposes and to aid coordination amongst trades. All wiring, connections, means and methods is to be performed by others in strict adherence with all federal, state, and local building codes.